



Getting Started With Your Aquathin PEARL 30 Water Purification System (In full color at www.aquathin.com)

Includes setup and maintenance information

**AN ISO 9001:2015 QMS
REGISTERED /CERTIFIED COMPANY
(IMS-0192 & NQA-12635)**

© 2009-2018 Aquathin Corporation. All rights reserved.

Under the copyright laws, this manual may not be copied, in whole or in part, without the written consent of Aquathin Corporation.

Every effort has been made to ensure that the information in this manual is accurate. Aquathin Corporation is not responsible for printing or clerical errors.

Aquathin Corporation

Aquathin Business Centre
950 South Andrews Avenue
Pompano Beach, Florida 33069
1-800-GO.2.RODI (462-7634) or 1-954-781-7777
Fax: 1-954-781-7336
Email: info@aquathin.com
www.aquathin.com

Aquathin Corporation, the Aquathin Corporation logo, Aquathin PEARL Water Purification System are trademarks and copyright of Aquathin Corporation. Product specifications are subject to change without notice.

Your Authorized Aquathin Dealer Is:

Dealer Name _____
Contact _____
Address _____

Phone _____
Fax _____
Email _____

Introduction

Thank You for your purchase. Aquathin turns **"40 in 2020"** to enjoy its **Ruby Anniversary** and it's a great feeling of self satisfaction and accomplishment to be an Authorized Aquathin Dealer. You could not have picked a better time to consider the many benefits of becoming a member of the ever growing Aquathin Family. The Next Quarter Century Celebration Begins!

Aquathin has earned 7 Patents and manufactures a broad spectrum of unique and proprietary water purification, softening and filtration systems servicing the residential, commercial and laboratory markets. Established in 1980, Aquathin now produces over 70 proprietary and trademarked devices for markets around the world through more than 600 Authorized Aquathin Dealers. Aquathin is an E.P.A. Registered manufacturer, ISO 9001:2008 Certified and recipient of the prestigious President's Excellence Award and E Star Award in Export from the U.S. Commerce Department and the Nation's Blue Chip Enterprise Initiative Award from the U.S. Chamber of Commerce. We have a very impressive global client list that now includes you and your family. Recently we have launched a project, two years in the making, for Authorized Aquathin Dealers to provide total home air and water security...and more. Visit the Aquathin Allergy Store online at www.aquathin.com.

Aquathin does not sell franchises nor do we charge for territories. We want to make sure that our Dealers are service oriented and knowledge driven. We know that even though we make the best water treatment systems in the world, ultimately they are only as good as the people representing them. And this is why we make the very best water treatment Dealers in world. Your local Authorized Aquathin Dealer has received training and continuous education from Aquathin University. You can be assured that when you purchase from an Authorized Aquathin Dealer (or from the factory directly in areas where we have yet to approve and establish a Dealer) you are receiving the finest equipment and technical support this industry is able to offer. Highest quality water treatment systems and support good enough for my home...my family.

And that is my promise to you! I love my Aquathin!!

**FOR THE BEST TASTE IN LIFE &
40 Years Pure Excellence**

*...and another Half Century re-inventing the water industry!
Think Aquathin...AquathinK !!
(visit the **NEW** www.aquathin.com)*

*"Alfie"
Alfred J. Lipshultz, President*

*P.S. Remember...the next best thing to owning an
Aquathin is recommending one to a friend !*

C o n t e n t s

| | | |
|----------|--|-----------|
| 1 | Getting Started | 7 |
| | Setting Up Your PEARL System | 8 |
| | 1. Unpack the System | 9 |
| | 2. Required Tools | 10 |
| | 3. Planning the Installation | 10 |
| | 4. Installing the Chrome Faucet Assembly | 10 |
| | 5. Installing the Feed Water Saddle Valve | 11 |
| | 6. Installing the Drain Saddle Valve | 12 |
| | 7. Preparing to Mount the Main Assembly | 13 |
| | 8. Making the Tubing Connections | 14 |
| | 9. Connecting Tubing to Speedfit® Fittings | 15 |
| | 10. Connect Cold Water Supply Line | 15 |
| | 11. Connect the Drain Line | 16 |
| | 12. Mount the Main Assembly | 16 |
| | 13. Prepare Storage Tank | 17 |
| | 14. Connect Main Assembly to Storage Tank | 17 |
| | 15. Connect GAC Post Filter | 18 |
| | 16. Power-up the Main Assembly | 18 |
| | 17. Connect to Ice Maker – optional | 18 |
| | 18. Option for Low Source Pressure (PBA-G) | 19 |
| | Verify the Tubing and the Flow | 19 |
| | Starting Your System | 20 |
| | Indicators of System Activity | 21 |
| | Operation Procedure | 23 |
| 2 | Getting to Know Your System | 24 |
| | A Look at the Key Components | 24 |
| | Aquathin Sediment Pre-Filter | 24 |
| | Granular Activated Carbon Pre-Filters | 25 |
| | Aquathin Reverse Osmosis Module | 25 |
| | Aquathin Deionization Module | 26 |
| | Operating Parameters | 27 |
| | Pressure | 27 |
| | pH | 27 |
| | Chlorine and Chloramines | 27 |

| | | |
|----------|---|-----------|
| | Sediment | 28 |
| | Iron | 28 |
| | Hardness and More | 29 |
| 3 | Maintenance And Servicing | 31 |
| | Exterior Cleaning | 31 |
| | Flushing | 31 |
| | Filter Replacement | 32 |
| 4 | Frequently Asked Questions | 38 |
| 5 | Limited Warranty | 42 |
| | What The Warranty Covers | 42 |
| | Exceptions To Lifetime Warranty | 42 |
| | What We Will Do To Correct An Inconvenience | 43 |
| | How State Law Relates To The Warranty | 43 |
| A | ppendix A - Specifications | 44 |
| A | ppendix B - Replacement Schedule | 46 |
| | Replacement Components | 46 |
| | Maintenance Log | 47 |
| A | ppendix C - Connections | 48 |
| | C1—Sink Mounted Faucet Assembly | 48 |
| | C2—John Guest Speedfit® Fitting | 49 |
| | C3—PEARL Installation Diagram | 50 |
| | C4—PEARL Installation (with pump) | 51 |
| | C5—PEARL Schematics | 52 |
| A | ppendix D - Optional Pump | 53 |
| | 1. Prepare to Mount the Pump | 53 |
| | 2. Connect Pump Inlet to Feed Assembly | 54 |
| | 3. Connect Pump Outlet Sediment Pre-filter | 55 |
| | 4. Mount the Pump | 55 |



CHAPTER
1

GETTING STARTED

Thank you for purchasing this quality water purification system by Aquathin Corporation. The Aquathin PEARL RO/DI is the ultimate sophisticated state of the art in water purification and began production in the early 1990's after successful lab testing and 20 year field experience. This user's manual serves for the installation of the PEARL. Every Aquathin PEARL system combines several efficient methods of water treatment to achieve a very specific result—pure water that meets the rigorous standards for biocompatibility.

As the new owner of an Aquathin PEARL RO/DI water purification system there is a totally new experience awaiting you. You and your family will be amazed at the delightful new taste of your tap water—it's like owning your own personal mountain spring.

This manual provides information about the application and servicing of your Aquathin water purification system. Descriptions of the components and their functions will help to answer frequently asked questions. By thoroughly reading this manual you will be better able to operate your new system and perform simple maintenance.

SETTING UP YOUR PEARL SYSTEM

Your Aquathin PEARL system requires adequate water pressure. The PEARL operates at 24 volts, utilizing a compact transformer that accommodates either 110 or 220 volts, so that you can take your system wherever you move. This unit is designed to operate within a pressure range of 40–100 PSI. The amount of purified water produced depends primarily on your water pressure, temperature, and the amount of Total Dissolved Solids (TDS). Normal production averages up to 45 gallons (≈ 170 liters) per day. If you plan to install this unit on a private well system, you should check your water pressure gauge. If the low pressure setting is less than 40 PSI, ask a plumber to adjust and raise the pressure to the minimum level of 40 PSI. An optional booster pump (PBA-G) is available when source pressure is severally low. Installation to comply with state and local laws and regulations.

IMPORTANT NOTE:

For private well owners we recommend that you choose the Aquathin PEARL with PBA-G booster pump system which includes a booster pump and is completely configured at the factory. This eliminates fluctuations in line or low pressure associated with private wells and ensures your PEARL system operates at peak efficiency. While 45PSI is enough to produce water with exceptional purity required for passing Aquathin standards, you may find water flow to the faucet is less than optimal, and that your holding tank will not store much water. (The amount of water stored is a function of line pressure).

Installing Your A System Requires the Following Steps:

- ◆ Install the sink-mounted chrome faucet.
- ◆ Install the feed water saddle valve to deliver tap water to your system.
- ◆ Mount the Frame Assembly to the cabinet sidewall (optional).
- ◆ Make the tubing connections.
- ◆ Install the Platinum Booster Assembly (PBA-G) to provide ample water pressure (optional).

1. Unpack the System

Contents include:

1. Main filter assembly, with sub-sink frame & filters
2. Faucet assembly
3. Storage tank
4. Tank ball valve
5. Feed water saddle valve
6. Drain saddle valve
7. GAC post filter (CARB 6)
8. Ice maker tee (optional)
9. Platinum booster assembly, including pump and pressure gauge (optional)
10. Tubing
11. Spanner Wrench

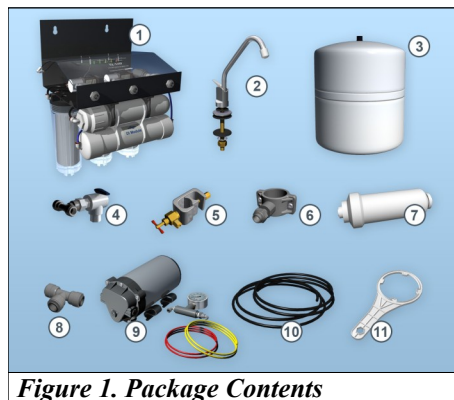

Figure 1. Package Contents

2. Required Tools

| | |
|--|---|
| Hi Speed Drill | #2 Phillips Screw Driver |
| ¼" High Speed Drill Bit | Teflon thread tape |
| ½" High Speed Drill Bit | Razor knife with fresh sharp blade |
| ⅛" High Speed Drill Bit | Adjustable (Crescent) Wrench |
| For porcelain sinks, a Dremmel® tool and ¼" silicon carbide grinding wheel or a Glass & Tile carbide spade-tipped bit. | For granite counter-tops, you will need to have a professional drill a ½" hole. |

3. Planning the Installation

Review the following instructions completely before proceeding. (See [installation diagram on page 49.](#)) Aquathin PEARL systems are comprised of several compact components which fit easily beneath most kitchen sinks. We encourage you to establish the desired location of each of the components before proceeding. Installing the main assembly against the left sidewall is recommended whenever possible. The storage tank has built-in feet for upright positioning and it can be placed on its side when space is limited. (A stand is included.)

4. Installing the Chrome Faucet Assembly

- 1) Select a location for the faucet on the sink top.

NOTE: Make sure there are no reinforcing ribs under the sink drilling location.

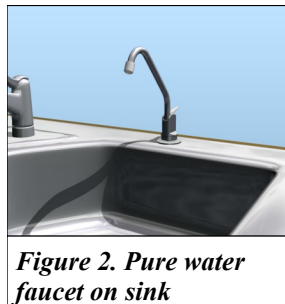
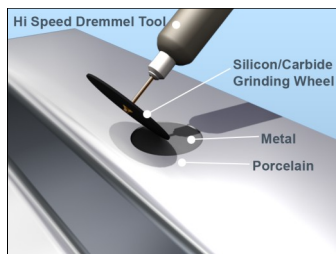

Figure 2. Pure water faucet on sink

2) Use factory approved method or approved plumbing practice to drill a 7/8" hole in the sink.



Porcelain sinks: factory approved method is: first grind away porcelain with a Dremmel® tool and silicon grinding wheel (about 3/4" circle).

Figure 3. Using a Dremmel Tool to remove porcelain

Then, use a standard 1/2" high-speed drill bit to drill hole through metal portion of sink. (insert figures) Alternately, use a "glass and tile carbide spade tipped bit."

Acrylic sinks: use 1/2" high-speed drill bit.

Stainless Steel sinks: use 1/2" high-speed drill bit or 1/2" Greenlee chassis punch.

3) Install faucet according to detailed diagram in [Appendix C1, page 47](#), insuring rubber gaskets are in place.

4) Tighten lock nut beneath sink. Save compression fitting parts for connection to GAC post-filter.

5. Installing the Feed Water Saddle Valve

The saddle-type valve supplied is intended for use on 3/8" to 1/2" copper tubing cold water supply line. It is not intended for flex lines.

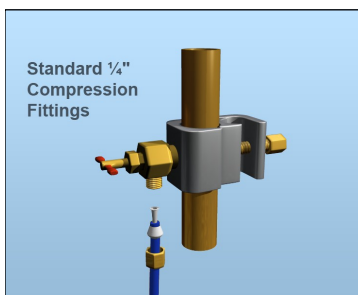

Figure 4. Feed water saddle valve.

NOTE: Color coding of tubing is for installation purposes.

Install on cold water line only!

Turn off the cold water valve under the sink or the main valve for the house. Slide clamp over the copper tubing and tighten screw firmly to hold the clamp in position. Pierce the copper tubing by turning the needle valve handle clockwise until it is firmly seated. The valve is closed in this position. Turn on the MAIN supply valve to pressurize cold water line. Immediately check for any signs of leaks. Set aside compression fittings for later use in connecting feed tubing to system.

When ready to supply water to the system, turn valve handle counter-clockwise until fully open. In some instances the self-piercing valve provided will not be compatible with your plumbing. We have provided a feed valve that will satisfy most scenarios. Alternate parts using standard 1/4" compression fittings can be found at a plumbing supply or at home improvement stores. On rare occasions, it may be necessary to contact a plumbing contractor to complete your installation.

6. Installing the Drain Saddle Valve

The drain saddle assembly should be installed above the trap and on the vertical or horizontal tailpiece. (See Figure 5). Refer to Figure 6 (next page) and

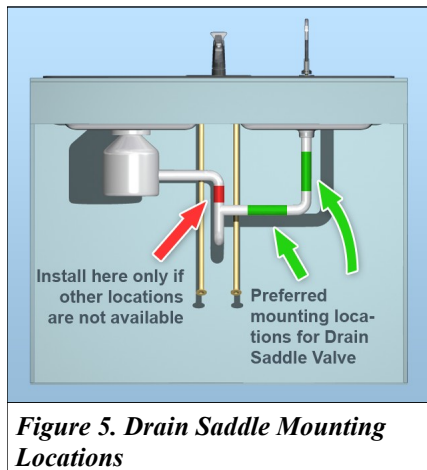

Figure 5. Drain Saddle Mounting Locations

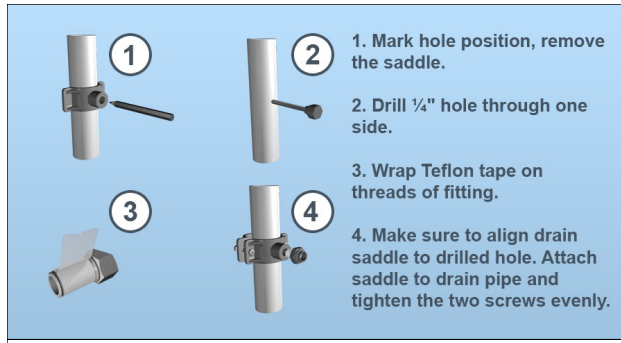

Figure 6. Mounting the Drain Saddle Valve

follow steps 1 through 4 to mount the drain saddle valve.

NOTE: When installing the Main Assembly, mount the frame above the position of the drain saddle whenever possible. (See Figure 11 on page 16).

7. Preparing to Mount the Main Assembly

When possible we recommend mounting the main assembly on the left sidewall of the cabinet, but this is not a requirement. Mounting the system as shown in Figure 7 will save cabinet space.

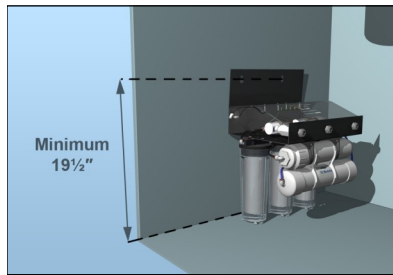

Figure 7. Mounting Arrangement in the case of Limited Cabinet Space

Install the screws (Figure 8) provided allowing for the thickness of the frame. (A pilot hole using a 1/16" drill bit is recommended for particle board side-walls.)

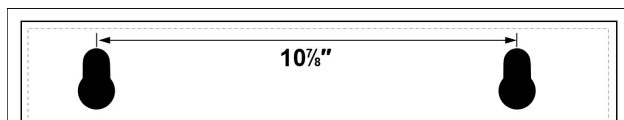

Figure 8. Spacing between keyholes (figure not drawn to scale)

NOTE: Do not hang the assembly until tubing connections have been made (following pages.)

8. Making the Tubing Connections

You have completed the bulk of the installation tasks. All that remains is connecting tubing between the components.

The tubing is to be used to:

- ◆ Connect the feed water saddle valve to the inlet on the main assembly (indicated by “TO FEED”)
- ◆ Connect the Drain Saddle Valve Assembly to the inlet on the main assembly frame (indicated by “TO DRAIN”)
- ◆ Connect the tank to the inlet on the main assembly (indicated by “TO TANK”) and as well to connect the tank to the faucet through the GAC post filter (CARB 6).

NOTE: It is important to correctly measure the required length of the tubing for each connection prior to cutting the tubing. Additional yellow and red tubing are provided if you opted for the pump (PBA-G).

9. Connecting Tubing to John Guest Speedfit® Fittings

Aquathin systems make extensive use of John Guest Speedfit® fittings. These high quality components provide secure, leak free seals and make it easy to connect and disconnect tubing without the use of tools. Refer to [diagrams on page 48, Appendix C2](#).

10. Connect Cold Water Supply Line

Measure and cut a length of tubing to connect the feed water saddle valve to the left inlet on the frame assembly (indicated by “TO FEED”).

Connect the tubing to the saddle valve using the compression fittings provided. (See [figure 9](#) and [installation diagram on page 49](#).)

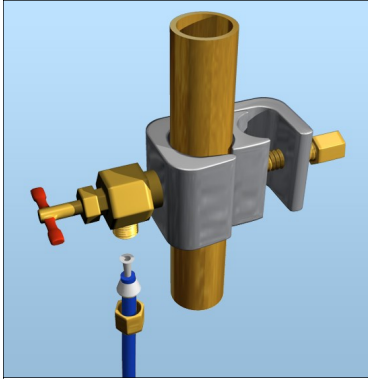

Figure 9. Connect tubing as shown (color coding of tubing is for installation purposes)

Cut tubing so the end is square to ensure a leak free seal. Cut tubing with a fresh, sharp blade and a slicing motion to avoid crimping. See [figure 10 on the right](#).

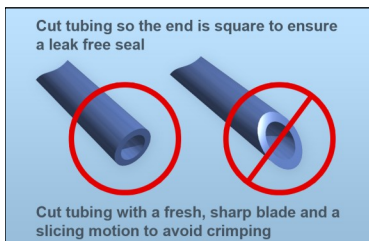
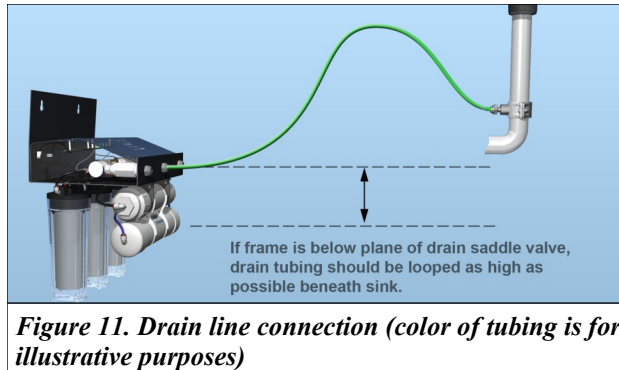

Figure 10. Cut tubing square; do not use scissors

11. Connect the Drain Line



Measure and cut a length of tubing to connect the drain water check valve (indicated by “TO DRAIN” on the frame assembly) to the drain water saddle valve.

IMPORTANT: Be sure to measure the tubing appropriately before cutting. If the frame of the main assembly is not above the drain saddle valve, you will need to loop the tubing as high as possible beneath the sink. Be sure to allow for this loop when you measure. A self-adhesive tubing clip has been provided to secure the drain loop.

12. Mount the Main Assembly

With the cold water supply and drain line connected, the main assembly can now be placed onto the screws previously installed. Place the keyhole openings over the screws then slide the frame horizontally onto the mounting screws. You may wish to remove the main assembly and adjust the screws to make the connection as secure as possible.

13. Prepare Storage Tank

Remove the plug on top of the storage tank, revealing an inlet. Wrap Teflon pipe tape on the threads of the storage tank inlet; then place three (3) drops of regular household chlorine bleach into the opening. Attach the tank

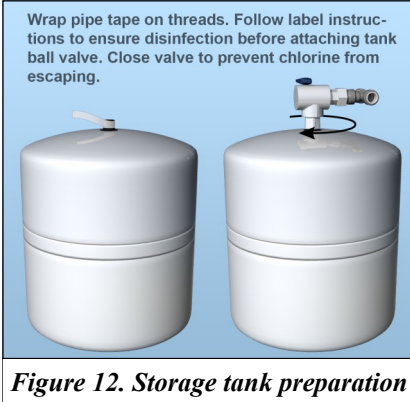

Figure 12. Storage tank preparation

ball valve as shown in the figure above. Close valve to prevent chlorine from escaping.

Close the tank ball valve by turning the blue handle perpendicular to the valve body; then screw the valve onto the storage tank until firm. DO NOT OVERTIGHTEN. Determine the position for the storage tank beneath the sink. If space is at a premium, it is OK to lay the tank on its side. A stand is included.

14. Connect Main Assembly to Storage Tank

With the tank in position, measure and cut a length of tubing to connect the inlet of the main assembly indicated by “TO TANK” and the “T” connector on the tank ball valve. (See figure 13.)

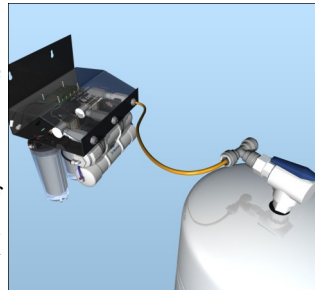

Figure 13. Main assembly to storage tank (color of tubing is for illustrative purposes)

15. Connect GAC Post Filter

Refer again to the PEARL [installation diagram on page 49 in Appendix C3](#). The GAC post-filter (CARB 6) is typically installed just below the faucet assembly and is easily supported by the tubing and Speedfit® fittings.

Measure and cut a length of tubing to connect the outlet of the GAC post-filter to the faucet assembly. Placing the post-filter near the tank will make it easy to service when needed.

Connect one end of the tubing to the threaded stem of the chrome faucet assembly using the 1/4" compression fittings provided. (See [diagram on page 49 in Appendix C3](#).)

Connect the opposite end of the tubing to the outlet of the GAC post-filter.

Finally, measure a length of tubing to connect the storage tank to the GAC post-filter.

Leave the handle on the tank ball valve closed at this point.

16. Power-up the Main Assembly

Connect the provided transformer to the main assembly as shown.

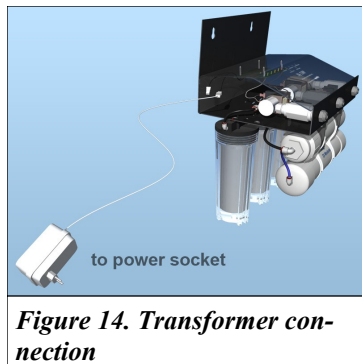
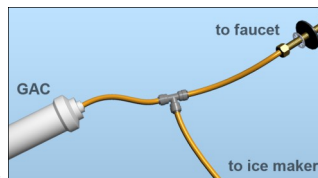

Figure 14. Transformer connection

17. Connect to Ice Maker – optional

Before connecting the GAC post-filter to the faucet assembly (as described above), connect the GAC post-

filter to the ice maker using the Ice Maker Tee provided. (See figure on the right.)



18. Option for Low Source Pressure (PBA-G)

If you experience fluctuations in line or low pressure, often associated with private wells, we recommend that you choose the PEARL with PBA-G booster pump system which includes a booster pump and is completely configured at the factory. (The amount of water stored is a function of line pressure). To setup and install the optional pump, refer to [instructions in Appendix D](#).

Figure 15. Connect the Ice Maker as shown (color of tubing is for illustrative purposes)

VERIFY THE TUBING AND THE FLOW

Tubing and flow depend on whether you chose to use the pump.

Without pump:

Cold water enters the main assembly through the “TO FEED” inlet. The water then passes through to the inlet of the Sediment Pre-filter.

The purified water exits the main assembly from the “TO TANK” outlet and passes through the tank and the CARB 6 GAC post-filter before reaching the chrome faucet.

With pump:

Cold water enters the main assembly through the “TO FEED” inlet. The water then passes through the pump to the inlet of the Sediment Pre-filter.

The purified water exits the main assembly from the “TO TANK” outlet and passes through the tank and the CARB 6 GAC post-filter before reaching the faucet.

Congratulations! You have completed the installation of your Aquathin PEARL water purification system. You are now ready to begin making pure, Aquathin quality drinking water.

STARTING YOUR SYSTEM

1. Open the chrome faucet on the sink top.
2. Verify the Tank Ball Valve is closed.
3. Slowly open your cold water supply valve. You will also begin to hear water flowing into the drain.
4. Check the pressure gauge on optional PBA-G. Record your initial pressure in Appendix B.
5. In approximately 20 minutes you will begin to see water drip from the faucet.
6. Close the faucet on the sink top, and then quickly open the Tank Ball Valve to allow the storage tank to fill. Actual production rate will vary slightly depending on pressure, but your system will normally produce up to 45 gallons of water per day, depending on model. The first tank of water may take longer.
7. **DISCARD THE FIRST FULL TANK OF WATER.** Open the faucet and let the water flow until only a trickle remains. Close the faucet and allow the tank to fill a second time. You are now ready to enjoy the great taste of 100% pure, Aquathin drinking water. (The RO Module contains a preservative solution that will be flushed after the first tank of water is produced.)

IMPORTANT: Monitor your system and check for leaks frequently over the first week.

Most leaks are attributed to tubing not fully seated inside the Speedfit® fittings. Remove the red lock clip, compress the collet, and remove the tubing. Re-insert the tubing until you feel it bottom out on the tubing end-stop. Replace the red lock clip. This process solves 99% of leaking connections. If the leak persists, trim ¼" – ½" off the end of the tubing and try again.

INDICATORS OF SYSTEM ACTIVITY

The main system has five light indicators on the frame. These are important indicators of the system activity.





The **first green light** (from left) indicates that the power is turned on. This light appears when the system is running, filling, or flushing. It remains lit even when the tank is full and when the pressure is low.

The **second green light** (from left) turns on only when the tank is full. Therefore, when the tank is full, both the green lights will be lit.

The **first amber light** (from left) is lit when the system is active, i.e. when water is either filling or when the system is flushing. Therefore, if the tank is full and the system is idle this light will not be lit.

The **second amber light** (from the left) is lit only when the system is flushing; flushing is an automated function in the Aquathin PEARL.

The **red light** indicates that the water pressure is low. If this light is turned on, you may need to use the optional pump system.

| | Green (power on) | Green (storage tank full) | Amber (system on/off) | Amber (system flushing) | Red (low feed pressure) |
|---------------------------|---|---|---|---|---|
| System running |  | |  | | |
| System flushing |  | |  |  | |
| Tank full |  |  | | | |
| Low water pressure |  | | | |  |

OPERATION PROCEDURE

Your Aquathin IQ-ΣMP Panel Subsink Reverse Osmosis / Deionization Water Purification System is self operational. The exclusive patented power panel does all the work! Each time the tank calls for water, the system will self flush the RO Module for 2 minutes and then manufacture water. Unlike other RO systems, this unique design helps to preserve the longevity of your RO Module by removing potentially plaquing debris.

NOTE: Should you leave your residence for a few days or more, turn off the cold water feed line, unplug the electric cord, and drain the tank via the faucet. Repeat the start up procedure when you return.

CHAPTER

2

GETTING TO KNOW YOUR AQUATHIN PEARL RO/DI SYSTEM

Your Aquathin PEARL system combines the three most effective water purification technologies available. Alone, each of these methods is highly effective for a particular group of pollutants—but only when combined can you be assured of complete removal of all contaminants. Every system combines Carbon Adsorption, Reverse Osmosis, and Deionization. By carefully matching the components utilizing these methods, we are able to assure your system produces water which meets or exceeds the standards for biocompatibility and purity.

A LOOK AT THE KEY COMPONENTS

Aquathin Sediment Filter

Water entering the system is first subjected to our spun-Polypropylene dual gradient (10-5 microns) sediment pre-filter. Any suspended particles such as sand, rust, or other deposits commonly found in the feed water supply are removed. This protects the RO Membrane from particles which might clog the pores. This pre-filter has been carefully selected for its extremely high dirt holding capacity and removal of oil emulsions.

Granular Activated Carbon & Anti-Microbial Filters

Before water reaches the reverse osmosis membrane, it is subjected to an “Aquathin unidirectional” Granular Activated Carbon pre-filter. Flow is lengthwise, not radial, for maximum contact time and organic adsorption, followed by an Aquathin AquaShield Anti-microbial Filter. Aquathin has designed twin carbon filters in this stage where other ordinary assemblers use only a single cartridge. By using twin cartridges we insure complete removal of organic contaminants including pesticides, herbicides, and other hydrocarbon based compounds.

A single gram of steam washed, bituminous grade, granular activated carbon typically has ~1500 square meters of surface area—meaning our twin GAC pre-filters provide over 400 acres (1.62 square kilometers) of surface area where organic contaminants dissolved in the water have an opportunity to be adsorbed and eliminated. This immense GAC surface area also insures complete and total conversion of chlorine and chloramine—protecting the Aquathin polyamide thin-film-composite (TFC) Reverse Osmosis Membrane downstream.

Aquathin Reverse Osmosis Module

A custom designed and extremely efficient High Flow (XF-HRO) spiral wound Reverse Osmosis Module produces up to 45gallons (≈170 liters) of purified water per day. The Aquathin RO Module utilizes the unique properties of a semi-permeable material which allows passage of pure water molecules while not allowing dissolved salts, heavy metals, organics and disease causing water-borne microorganisms to pass through.

Our extraordinary module is designed to consistently and significantly reduce the total dissolved solids in the source water supply by greater than 97%. It also has a tremendous capacity to completely reject organic and

biological contaminants, including disease causing water-borne microorganisms. EPA EST. NO. 52531-FL-01

The Aquathin Reverse Osmosis Module used in this system can tolerate significantly higher concentrations of oxidizing contaminants like iron and manganese than RO modules found in other systems, as well as a much higher degree of hardness. However, there are limitations—the operating parameters for this module are found in the Specifications section of this manual.

Aquathin Deionization Module

This stage contains a unique blend of proprietary deionization resins carefully matched to our Reverse Osmosis Module and provides superior rejection of monovalent ions, fluoride, and nitrates; contaminants only partially removed by reverse osmosis. Including deionization after reverse osmosis sets Aquathin systems apart from other ordinary RO systems.

Following the DI resins, there is even more granular activated carbon to polish the product water for a clean, fresh taste. The flow rate at this stage provides tremendous contact time to assure complete removal of any remaining organic contaminants.

The final stages of our proprietary DI module are included to prevent the reverse migration of contaminants into the system. These stages further separate Aquathin systems from other brands. After carefully combining the previous components it is essential to integrate these stages to ensure 99.999% removal of bacteria, cyst, and virus (EPA EST. No. 52531-FL-01). These stages also prevent any contaminants from entering the system via the faucet.

OPERATING PARAMETERS

To insure proper operation of your PEARL system, it is advisable to collect the following information about your water supply. This information is generally available from your municipal water department, and in many cases is available from the website of your local Department of Public Works.

Pressure

In order to overcome the natural osmotic force, adequate water pressure must be available from your water supply. The osmotic force is directly proportional to the concentration of dissolved solids in the water. When the water pressure is equal to the osmotic force, there will be no movement of pure water molecules across the semi-permeable reverse osmosis module. A minimum of 45 PSI is required. (If your water pressure is below 45 PSI, a booster pump is available. If you are on a private well, have your plumber raise the minimum pressure above 45 PSI.)

In general, the higher the pressure (up to 100 PSI), the better the performance of the module at rejecting contaminants.

pH

The Aquathin HRO TFC module will hold up very well when the pH of the feed water is between 2 and 11. Water supplies with pH over 11 are very rarely, if ever, found. (Chlorine bleach has a pH of ~11.5.)

Chlorine and Chloramines

Chlorine is the most common substance added to municipal water supplies. Its purpose is to eliminate biological growth (i.e. chlorine is toxic). Regulations usually require there be residual chlorine when water

reaches your tap. Typically, the residual concentrations of chlorine in household water range from 0.5 to 1.0 parts per million (ppm).

Besides being toxic, chlorine and chloramines will degrade the TFC Reverse Osmosis Module. Therefore, it is essential to remove chlorine from your feed water before it reaches the RO Module. Your Aquathin RO/ DI system includes a pre-filter containing a special grade of grade of Granular Activated Carbon (GAC) which will very effectively remove chlorine and chloramines from your tap water. It is important to replace the pre-filter annually to insure no chlorine is reaching the membrane.

Sediment

In areas with very high sediment concentrations the Aquathin pre-filter may clog prematurely. If the pre-filter becomes clogged, you will likely notice a decrease in the production rate from your system. In areas with very high sediment concentrations, it may be necessary to replace the pre-filter on a semi-annual basis.

Over the course of one year, the sediment filter will typically become significantly discolored. This is not cause for alarm. If you notice pressure at the gauge has dropped significantly below your initial observations, consider changing this filter to restore adequate pressure and improve overall system performance.

Iron

Iron concentrations greater than 0.1 mg/l can degrade overall system performance. If your water supply has iron concentrations above 0.1 mg/l, pretreatment is recommended for ordinary RO systems. Your patented Aquathin process will tolerate up to 3 ppm iron.

Hardness and More

Two thirds of the water on earth is groundwater. As it

travels through rock and soil it picks up particles of calcium, magnesium, iron, lead, and other minerals. For 85% of the country, that translates into “hard water”. “Hardness” refers to the amount of calcium and magnesium in the water and is measured in grains per gallon (gpg). The following guide defines your water’s hardness based on two different measurements. Our test determines the grains of hardness that can easily be converted into the ppm.

| Description | Grains of Hardness | Parts per Million | Laundry Detergent Required |
|------------------------|---------------------------|--------------------------|-----------------------------------|
| Soft (ideal) | 0.0—1.0 | 0—18 | 1/4 dispenser |
| Slightly Hard | 1.0—3.5 | 18—60 | 1/4 dispenser |
| Moderately Hard | 3.5—7.0 | 60—120 | 1/2 dispenser |
| Hard | 7.0—10.5 | 120—180 | 1/2 dispenser |
| Very Hard | 10.5—over | 180—over | Full dispenser |

Most of the problems associated with hard water are economical in nature. Hardness causes unsightly soap scum on fixtures, water spots on glasses and whitish scale deposits in your tubs and showers. Hard water means you use more soap and cleaning agents because they first have to “clean” the water before they clean anything else.

Here is a little additional information about the ordinary RO systems sold in hardware stores and wholesale clubs:

1. They state their systems must be installed on water with less than 10 grains of hardness. Otherwise you need an expensive water softener just for the RO system. Your Aquathin can be installed on hard water up to 25 grains due to the patented flush.
2. There is a disclaimer that those units may not be installed on microbiologically unsafe water. But would that not be a reason one would purchase a system? Your Aquathin will remove disease causing waterborne microorganisms.
3. Their warranty is one year, but does not cover the RO module, yet that is the heart of the unit. When service is needed, you must ship the system out of town. Some require the module to be replaced every 6 months according to them. Your Aquathin carries a Lifetime Warranty except for normal filter changes and abuse.

You originally invested in your Aquathin to provide your family the very best in total home water security. There is hardly anything in this world that a man could not make a little worse or a little cheaper, and the people who consider price alone are this man's lawful prey. It's like this: we would rather explain price once than apologize for poor quality and service the rest of our life. In 1980 Aquathin made the decision at the onset; that we would never sacrifice or lower quality for price... too much depends on it. Would you prefer that your family drink from a system whose poor technology and cheap design allows them to continue to consume contaminates... or a product that provides the safest and most pure drinking and cooking water available?

I LOVE MY AQUATHIN!



CHAPTER

3

MAINTENANCE AND SERVICING

Minimal work is required to keep your Aquathin PEARL system in peak operating condition. Simply replace the filter modules as recommended. These simple steps will insure your unit consistently produces ultra-pure water meeting Aquathin standards.

Take care of your Aquathin system and it will provide many years of healthy drinking and cooking water for your entire family.

1. Exterior Cleaning

The exterior surface of your Aquathin can be kept looking like new by occasionally cleaning the surfaces with a soft cloth. Great care was taken in the choice of material for your unit, but the frame and filter housing cannot withstand harsh chemicals or solvents. Use a mild, non-abrasive dish washing detergent or diluted spray cleaner to remove smudges or food stains, then rinse and dry the surface. Use of abrasive scouring powders or glass cleaning products containing ammonia are not recommended.

2. Flushing

Flushing is the single most important maintenance

function needed to keep your system operating at peak efficiency and it extends the service life of the reverse osmosis module. This simple operation has been automated in the Aquathin PEARL.

If your unit has not been used for more than one week (e.g. while you are on vacation), drain the storage tank (use the water for watering plants, etc.) then flush the module as described above.

3. Filter Replacement

After 12 months of use, it is time to replace the Aquathin sediment pre-filter, the Aquathin twin carbon filters and the 4-stage Aquathin Deionization (DI) Module to insure your system is producing water within RO/DI parameters. After 2-3 years (depending on the level of contaminants in water), the Reverse Osmosis (RO) Module should be replaced, along with the post filter (CARB 6). Replacement modules can be ordered directly from your local Authorized Aquathin Dealer.

1. Remove the contents from beneath the kitchen sink where the Aquathin filter assembly is located.
2. Turn off the cold water supply line and unplug the transformer.
3. Drain ALL the water from the storage tank by opening the sink mounted faucet.
4. Place a soft clean towel on the working surface – it will absorb the small amount of water that will spill from the modules as they are changed out, and it will protect the surface of both the table and your Aquathin cabinet.
5. Close the faucet and the ball valve on the top of the storage tank

Replacing the Aquathin Sediment Pre-filter

The sediment pre-filter is in the canister on the left side of the assembly. The sediment pre-filter will likely be distasteful looking—it is common for sludge to form on the filter surface. After one year, this sludge layer can be fairly thick. ***The good news is, if the sediment filter and the PEARL did not catch this “guck”, your body would !!***

- a) Push the red button (on the top of the aluminum frame, above the pre-filter canister) to reduce any back

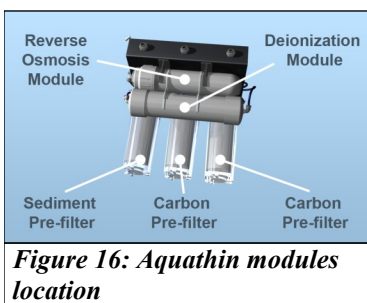

Figure 16: Aquathin modules location

- pressure remaining in the canister.
- b) Firmly grasp the canister with both hands and unscrew it from the pre-filter assembly. (A canister wrench is included.) Carefully move the canister over the bucket, dump the water, and remove the old pre-filter.
- c) Using a long handled, soft bristle brush, scrub the inside of the canister with a mild dish washing detergent and rinse.
- d) Place the new pre-filter into the canister, and then carefully re-attach the canister to the assembly. Tighten until firm.

Replacing the Aquathin Carbon Pre-filters

The Aquathin carbon pre-filters are in the middle canister and the canister on the right. Follow the same procedure as described for replacing the sediment pre-filter (above).

Replacing the Aquathin DI Module

Refer to (Figure 17) or to page 49, Appendix C2, for details on releasing tubing from Speedfit® fittings)

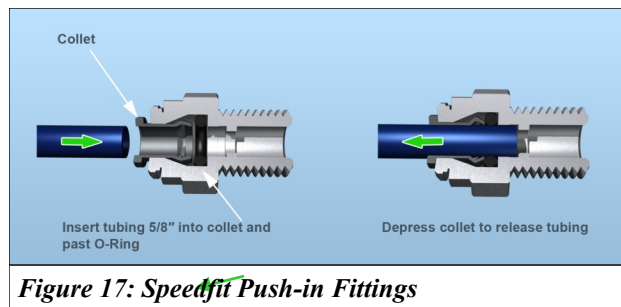

1. Disconnect the tubing from each end of the Aquathin De-ionization (DI) Module.

2. With the DI module free of its connections, it can now be removed from the two “Double C” clamps. (Figure 18). **Note the direction of the “ F L O W ” arrow. The new DI module must have the same orientation.**

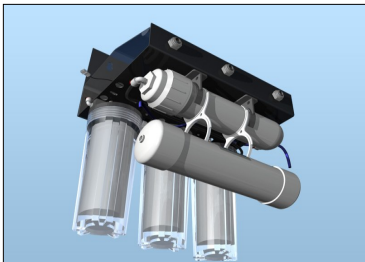

Figure 18: Step 2 - removing the DI module from the clamps

3. Place the new Aquathin DI Module into the housing. Re-insert the tubing which connects the reservoir to the DI Module, taking care to attach the tubing to the outlet end of the module.
4. Follow the system restarting procedure on page 37.

Replacing the Aquathin RO Module

1. Follow DI Module removal procedure on page 34
2. Remove the two “Double C” clamps.
3. One end of the RO Module has two connections: one blue tube connects to the Aquathin DI Module, and one black tube connects to the Aquathin drain valve assembly. Remove the black tubes from the RO Module.
4. Remove the black tube from the other end of the Aquathin RO Module.
5. Remove the RO Module from the two black C clamps which secure it to the Aquathin frame.
6. Unscrew the inlet cap and pull out the RO element from the module.
7. Clean the pressure vessel.
8. Place lubricant on the permeate tip of the new RO element.

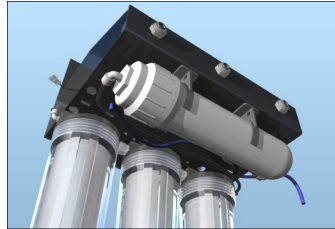

Figure 19: Step 5 - Remove the RO Module

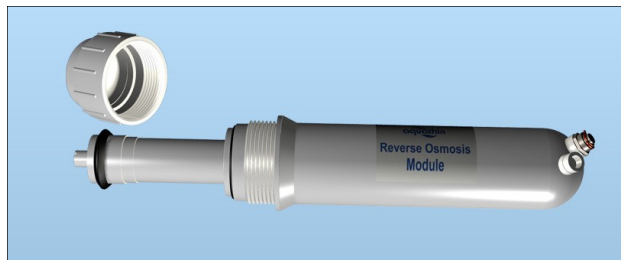

Figure 20: Step 6— Unscrew the inlet cap and pull out the RO element

9. Insert the element fully to be sure permeate tube completely enters internal cup.
10. Screw the cap back on.
11. Re-insert the RO Module back into the C- clamps.
12. Re-insert the black and blue tubing.
13. Snap the two “Double C” clamps back onto the RO Module.
14. Re-install the DI module as described previously.
15. Follow the system restarting procedure on page 37.

Disinfecting the tank

After the RO Module replacement you must disinfect and sterilize the storage tank. Carefully place a few drops of regular household bleach into the tubing that connects the outlet of the DI module with the storage tank before connecting the tubing to the DI module. (As the tank fills with water for the first time, it will be subjected to a strong but continually diluting solution of chlorine.)

Alternate disinfection procedure:

- a) Disconnect the tubing from the “T” connector on the tank ball valve and remove the storage tank from beneath the sink.
- b) Wrap a towel around the ball valve and slowly unscrew the valve from the storage tank. Water may remain in the tank and it will escape when the valve is removed. After setting the valve aside, place the towel over the tank opening and shake and rotate the tank to remove remaining water.
- c) Re-wrap the threads with Teflon® pipe tape.
- d) Now place a few drops of liquid chlorine bleach into the top of the tank and re-install the tank ball valve (with the valve in the closed position).
- e) Reconnect the tubing to the swivel “T” connector.

Restarting your System

When all filters have been replaced and all tubes have been reconnected, hook the unit up to the faucet and turn on the water. Let the unit produce water for 10–15 minutes then drain the water, invert the unit, and inspect for leaks. If any water appears at any of the tubing connections, remove the retaining clip, remove and reinsert the tubing. Replace the retaining clip. (A leaking connection is extremely rare.)

You can now return the unit to service. Let the reservoir fill and discard the first tank of water (use it to water plants, etc.) You are now ready to again enjoy great tasting, pure Aquathin RO/DI water for another 12 months!



CHAPTER

4

FREQUENTLY ASKED QUESTIONS

Q: How long will my sediment pre-filter last before it needs to be replaced?

A: Under typical conditions, the pre-filter is designed to function properly for 12 months, and should be replaced annually. Sediment concentrations vary greatly between municipal systems and well waters so there is no way of determining the lifetime of a filter without knowing more about the tap water. In some cases, it may be necessary to replace the pre-filter more frequently.

Q: How long will my GAC pre-filters last before they need to be replaced?

A: Your Aquathin PEARL system has been designed to operate within a wide range of tap water conditions. These conditions vary greatly across municipalities, so it is difficult to state precisely how long your pre-filters will last. We have designed the system so that under the most extreme conditions your pre-filters will still be performing correctly after 12 months of use. Following an annual replacement schedule will insure your system is consistently performing as designed producing ultra-pure water which meets the standards for bio-compatibility.

Q: How long will my CARB 6 post-filter last before it needs to be replaced?

A: Your Aquathin PEARL system has been designed to operate within a wide range of tap water conditions. These conditions vary greatly across municipalities, so it is difficult to state precisely how long your post-filter will last. We have designed the system so that under the most extreme conditions your post-filter will still be performing correctly after 12 months of use. The CARB 6 post-filter should be replaced when changing the RO module (once in 2-3 years). This will insure your system is consistently performing as designed, producing ultra-pure water that meets the standards for biocompatibility.

Q: How long will my reverse osmosis module last?

A: The module's life depends on the water conditions as listed in the specification section of this manual. If all these conditions are met, the life of the module is generally 2–4 years. If a module fails or its performance becomes reduced before this time, the cause can usually be traced to tap water conditions outside the specifications or failure to flush.

Q: How do I know if there is a problem with the module?

A: The best method is to measure the resistivity (conductivity) of the RO water and compare it to the tap water. You can invest in a reliable and inexpensive resistivity meter available from your Authorized Aquathin Dealer or you can send them samples for analysis. (Poor rejection rates may also be an indication of a clogged pre-filter, so check that filter first.) A large increase in the production rate is also an indication of module failure, and can often be traced to the module having been subjected to either freezing or hot water.

Q: How can I monitor the performance of the unit?

A: Your Authorized Aquathin Dealer will register your warranty card and purchase with Aquathin Corporation. Every year upon the anniversary of your installation,

Aquathin Corporation and your Aquathin Dealer will mail or email an Annual Service Reminder to have your system inspected and serviced if necessary. Also, with identical feed water pressure, the production rate should remain fairly constant. If your system begins to produce water at a much faster rate, the RO module may have failed. If your system is producing water at a much lower rate, replacing the pre-filter is often indicated. To monitor the overall system rejection rate, the best method is to obtain either a resistivity meter or TDS meter from your Authorized Aquathin Dealer.

Q: Will I lose valuable minerals when I drink purified water?

A: No, the body does not readily assimilate the minerals found in drinking water. We obtain the majority of our minerals from the foods we eat. There are many more bio-available “chelated” minerals in a piece of fruit or a serving of vegetables than in several gallons of water.

Q: Will pure water leach minerals from my body?

A: This question reflects one of the common myths that are found in the water industry. It has no basis in fact or physiologic science. Pure water does perform a valuable function by helping the body eliminate wastes and unused minerals that have been excreted from cellular tissues, but it does not “leach” minerals out of the cells. This false claim was probably first made by companies wanting to boost sales of filters incapable of removing dissolved minerals and dangerous heavy metals. ASK your Authorized Aquathin Dealer for a copy of “5th Functions of Water”.

Q: Will hot water ruin my RO module?

A: YES! Hot water over 100° F will damage the module and void your warranty. Make sure you use only COLD water in your Aquathin system.

Q: How should I store my purified water?

A: Ask your Authorized Aquathin Dealer about clear Aquathin polycarbonate bottles.

Q: How should I store my unit when not in use?

A: If your unit is not used for several days, no special precautions are required. **NOTE: SHOULD YOU LEAVE YOUR RESIDENCE FOR A FEW DAYS OR MORE, TURN OFF THE COLD WATER FEED LINE, UNPLUG THE ELECTRIC CORD, AND DRAIN THE TANK VIA THE CARAFE. REPEAT THE START UP PROCEDURE WHEN YOU RETURN.**

Q: How long does it take to make a tank of water?

A: The rate your system produces water is dependent upon several factors including source water pressure, temperature, and the amount of total dissolved solids (TDS). We rate our modules very conservatively, and the PEARL systems come with a up to 45 gallons of water per day module.

Q: When system enters flush mode, it makes noise. Is this normal?

A: When your system is flushing, water is flowing to the drain much faster than normal production mode. The check valve will sometimes chatter with the increased flow, and this can be heard as a hum or rattle. When your system is first put in service, there may be air in the lines that can also cause noise from the system. After a few days the noise typically will go away.

Q: How can I keep informed about Aquathin?

A: “Splash News Bulletin”, “Forum Q&A”, “Allergic Reaction”, “Biz Bank”, “Tech Bank”, and “Quote Bank” are all FREE services to all Authorized Aquathin Dealers and their Customers to keep you abreast of technology updates and industry news.

Email Aquathin at info@aquathin.com to subscribe.

Visit www.aquathin.com.

CHAPTER

5

LIMITED WARRANTY

Aquathin Corporation warrants to the original owner of each PEARL water purification system to be free from defects in materials and workmanship for as long as you own the product.

What The Warranty Covers

Full Lifetime Warranty on all parts (excluding normal module changes or abuse). 2 years on electronic components.

Your PEARL pure water appliance is a sophisticated water purification system. Failure to follow the maintenance schedule or use other-than genuine Aquathin components will void the exclusive lifetime warranty.

Exceptions to Lifetime Warranty

The Lifetime Warranty does not include damage caused by or resulting from unreasonable use, including failure to provide reasonable maintenance, or incidental or consequential damages, such as water damage, mold or damage to appliances, fixtures or other equipment.

Warranty will be void if product failure or damage is due to any of the following:

1. Misuse, misapplication, neglect (e.g. inadequate fil-

ter changes), alteration, hot feed water, freezing, or accident.

2. Improper installation, operation, or servicing.
3. Use only Genuine Authorized Aquathin components to assure efficiency and to maintain your Warranty.
4. No one is authorized to change or add to this Warranty.

What We Will Do To Correct An Inconvenience

Upon notice, we will repair or replace covered defective parts, free of charge. If it is necessary to return the product to an Aquathin Dealer for service, the buyer must pay for any shipping or travel costs. Aquathin Dealer will pay for any return shipping charges in the U.S. for parts or products covered under the Warranty.

An Aquathin Dealer will furnish any factory labor to make repairs on parts or products returned to the factory that are covered under the Warranty.

How State Law Relates To The Warranty

Some states do not allow the exclusion or limitation of incidental or consequential damages, so the above limitation or exclusion may not apply to you. This warranty applies to the original purchaser and gives you specific legal rights. You may also have other rights which vary from state to state.



SPECIFICATIONS

Following are the recommended operating parameters for our custom rolled Reverse Osmosis Module:

| | |
|-------------------------------------|---|
| Module type | Aquathin Spiral Wound Polyamide Thin Film Composite (TFC) |
| Production | Up to 45 Gallons-Per-Day (GPD) |
| Maximum Operating Temperature | 40–100° F (4–38° C) |
| Operating Pressure | 40–100 psi (2.75–6.9 bar) |
| pH Range | 2.0–11.0 |
| TDS Level, Maximum | 2000 ppm |
| Turbidity | < 1.0 Net Turbidity (NTU) |
| Chlorine (Cl ₂) | 0.00 mg/l * |
| Hardness (CaCO ₃) | < 427 mg/l |
| Iron (Fe) | < 3.0 mg/l |
| Manganese (Mn) | < 0.05 mg/l |
| Hydrogen Sulfide (H ₂ S) | 0.00 mg/l |

*Every system is equipped with our unique combination pre-filter to remove sediment and chlorine.

You can obtain specifics about your water supply from either your local water department or your local Authorized Aquathin Dealer. If the parameters of your water do not fall within the specified ranges as noted above, please contact your local Aquathin Dealer for further options. Production is rated at optimum temperature of 70° F, 60 PSI, and 500 ppm TDS. Actual production will vary depending on local temperature, pressure, and TDS level.

Low tap water pressure will reduce the volume and quality of the water produced by your system. In low pressure situations (<40 PSI) RO/DI values cannot be assured. The addition of a booster pump (PBA-G) is strongly recommended.

ALWAYS USE COLD WATER—hot water will damage the TFC membrane.

The unit must not be allowed to freeze. Freezing water will expand inside the modules—damaging the membrane and potentially rupturing the filter housings. Damage of this type will void the warranty.

This system has been tested and certified by IAPMO R&T according to NSF/ANSI 58 and WQA S-300 for reduction of TDS. The concentration of TDS in water entering the system was reduced to less than or equal to the permissible limit for water leaving the system, as specified in NSF/ANSI 58 and WQA S-300. Testing was performed under standard laboratory conditions. Follow installation procedures and scheduled maintenance for optimum performance.

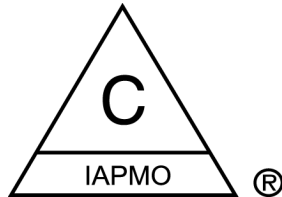

APPENDIX
B

REPLACEMENT SCHEDULE

Below you can find the recommended replacement schedule and part numbers for the components of your Aquathin water purification system.

Replacement Components

| Module | Replacement Schedule | Order No. |
|-----------------------------|-----------------------------|------------------|
| Sediment Pre-filter | Annually (or as needed) | 100+SED |
| GAC Pre-Filter AquaShield | Annually | 100+AS |
| 4-Stage Deionization Module | Annually | ADI |
| Aquathin Series RO Module | 2-3 Years (as needed) | XF-HRO |
| GAC Post-Filter | 2-3 Years | CARB 6 |

Purchase Date: _____

Purchased From: _____

Serial/Model Number: _____

Maintenance Log

| Module Replaced | Date |
|-----------------|------|
| | |
| | |
| | |
| | |
| | |
| | |
| | |
| | |
| | |
| | |
| | |
| | |
| | |
| | |
| | |
| | |
| | |
| | |
| | |
| | |

APPENDIX

C

C1. Sink Mounted Faucet Assembly

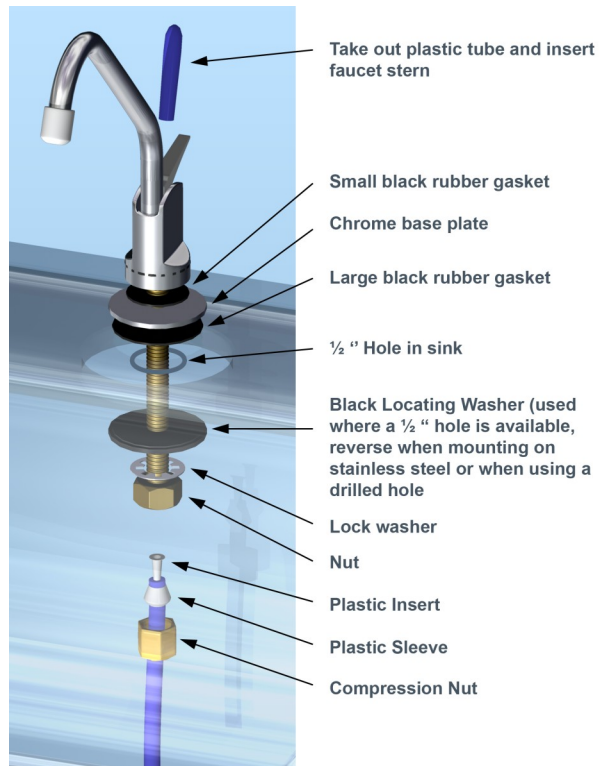

C2. Anatomy of John Guest *Speedfit*® Fitting

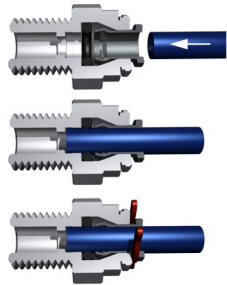
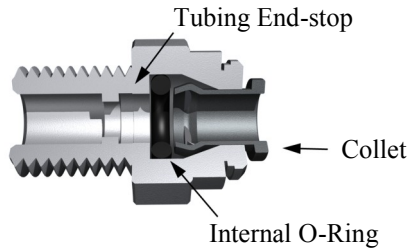

- 1) Insert tubing into fitting,
- 2) Past the Internal O-Ring,
- 3) Until it bottoms out against the tubing end-stop

Pull on tubing to ensure a secure connection, then slide red Lock Clip between collet and fitting.

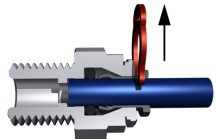

Remove the red Lock-Clip

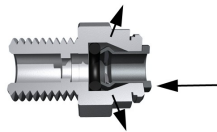

Push Collet up against body of the fitting, which will release the internal teeth.

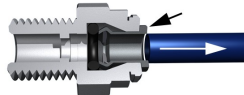

While compressing Collet, pull out the tubing.

C3. PEARL Installation Diagram

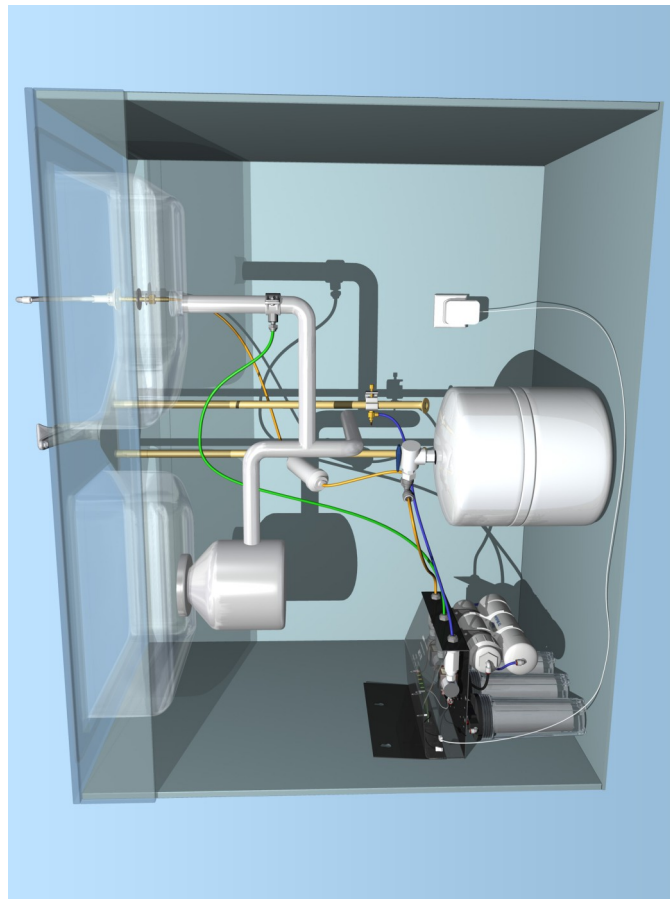

C4. PEARL Installation Diagram (with optional pump)

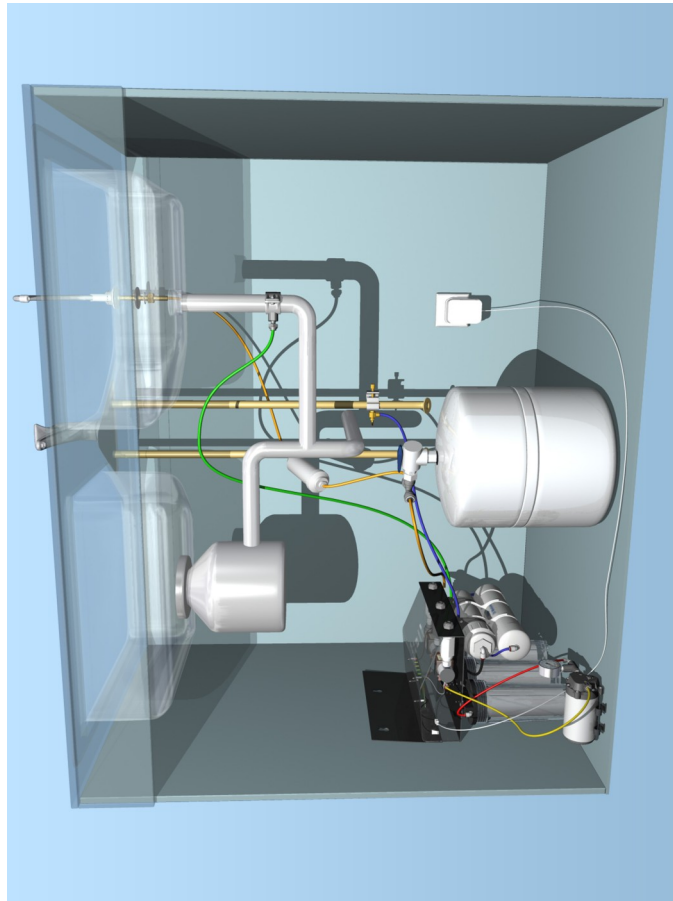

C5. Schematics

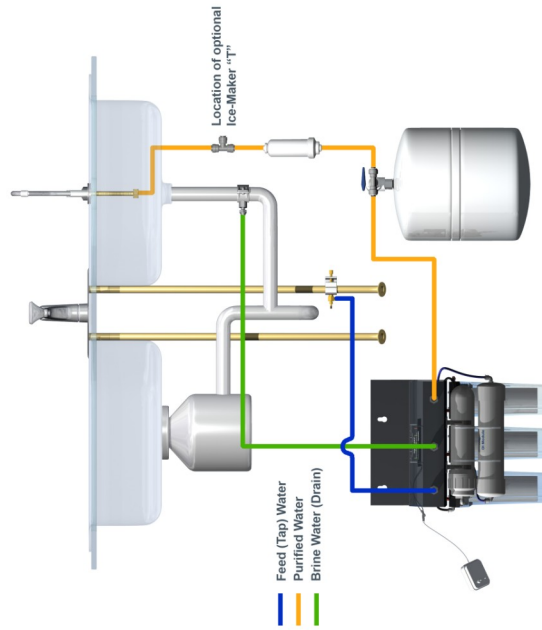

Purpose of diagram is to indicate tubing connection and location of components relative to water flow. Diagram is not drawn to scale and is not intended to indicate actual position of components beneath the sink.

APPENDIX
D

INSTALLING THE OPTIONAL PUMP

1. Prepare to Mount the Pump (PBA-G)

Identify a space to place the pump. The pump can be placed on the floor for convenience, preferably in close proximity to the main assembly. This will ensure that the tubing is kept to a minimum and is neatly arranged.

The pump may be mounted as well, however, do not mount the pump with screws until the tubing is completed.

In the main assembly, the sediment pre-filter is connected to the feed assembly and to the GAC pre-filters, such that the flow is indicated coming from the feed water assembly to sediment pre-filter to the GAC pre-filters. Remove the tubing that makes the connection between the feed assembly and the sediment pre-filter; the pump will be connected in between these (figure D1).

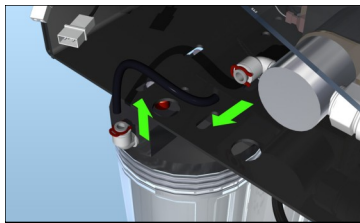

Fig. D1: Remove tubing that connects sediment pre-filter to feed assembly

2. Connect the Pump Inlet to the Feed Assembly

The Platinum Booster Assembly (PBA) includes both a pump and a pressure gauge. Remove the blue plugs on the pump by depressing the collets (figure D2).

Measure and cut a length of the **yellow** tubing to connect the pump to the feed assembly. Insert one end of the **yellow** tubing to the feed assembly **outlet** as shown in Figure D3 (where the sediment pre-filter was previously connected).

Insert the “T” connector of the pressure gauge in the pump **inlet** (Note the arrows indicating the flow). Refer to figure D4.

Insert the **yellow** tubing into the **other end** of the “T” connector. (Figure D5)

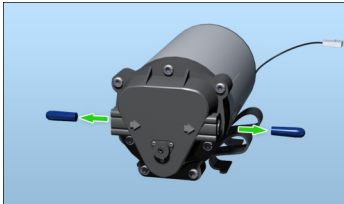

Fig. D2: Remove the plugs

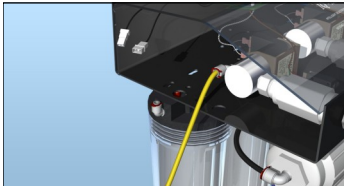

Fig. D3: Connect yellow tubing to the feed assembly



Fig. D4: Connect pressure gauge to pump

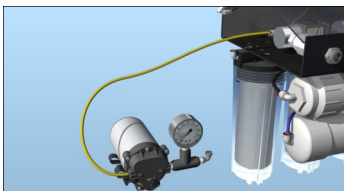

Fig. D5: Insert yellow tubing from the feed assembly to pressure gauge

3. Connect the Pump Outlet to the sediment pre-filter

Measure and cut a length of the **red** tubing to connect the pump to the sediment pre-filter.

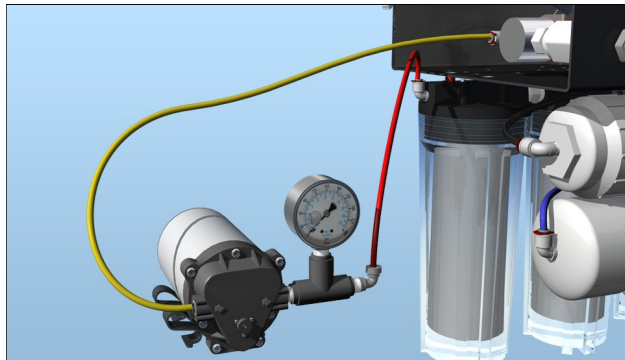

Fig. D6: Connect red tubing from pump outlet to sediment pre-filter inlet

Insert one end of the **red** tubing into the pump **outlet**, and the other end of the tubing in the sediment pre-filter **inlet**.

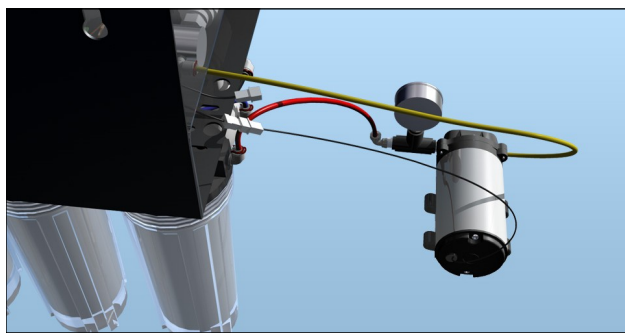

Fig. D7: Connect pump to pump jack on main frame

(Note the arrows indicating the flow on both the pump and the sediment pre-filter).

4. Mount the Pump (PBA)

Connect the pump to the Pump Jack on the main assembly (see [figure D7](#)).

With the pump inlet, outlet and Pump Jack connected to the main assembly, the pump can now be mounted with screws in the position previously identified. (A pilot hole using a 1/16" drill bit is recommended for particle board side-walls.)

NOTE: you may rotate the face of the pressure gauge, if needed, for easier reading.

www.aquathin.com

EPA EST. NO. 52531-FL-01



40 Years Pure Excellence

www.aquathin.com



7 Patents Earned



8 Trademarks



Over 70 Systems



75% of the Earth is covered by it

75% of the human body is made of it

aquathin

Aquathin purifies 100% of it.

aquathin USA

Purifying the Waters of the World for the Best Taste in Life!



EPA EST. NO. 52531-FL-01